

SWING GATE OPENERS



Self learning using intelligent positioning technology.

Ultra quiet operation yet powerful.

Die-cast Aluminium motor cover for great durability.

Mechanical stopper built in the motor for added protection.

No stoppers required on your driveway.

Optional Battery Back-up.

Waterproof cover design.

Soft start and soft stop.

Easy installation, plugs into a normal power point.

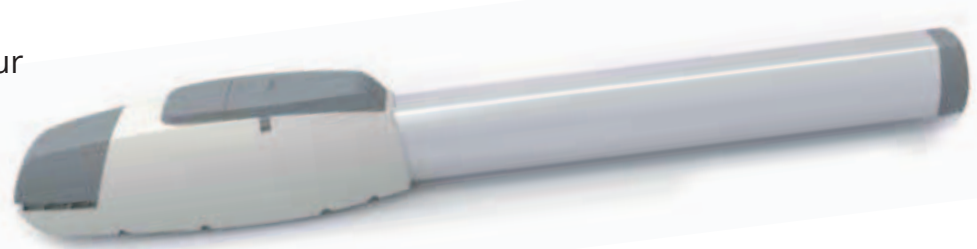

24V Heavy Duty Gear Motor

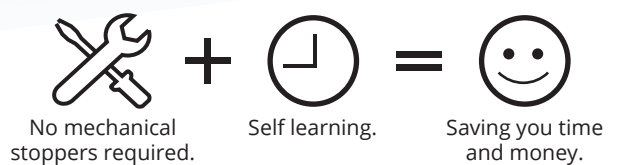

Technical Data

Power Supply	240 Volts AC
Motor Supply	24 Volts DC
Max Gate Weight	300kg
Max Gate Length	4 Metres
Peak Thrust	3000N
Operation Stroke	350mm
Motor Speed	25.5mm/sec
Typical Gate Opening Time	20sec
Duty Cycle	20%
Operating Temperature	-20°C-50°C



www.acdcms.com.au

02 9525 9588

Typical Installation

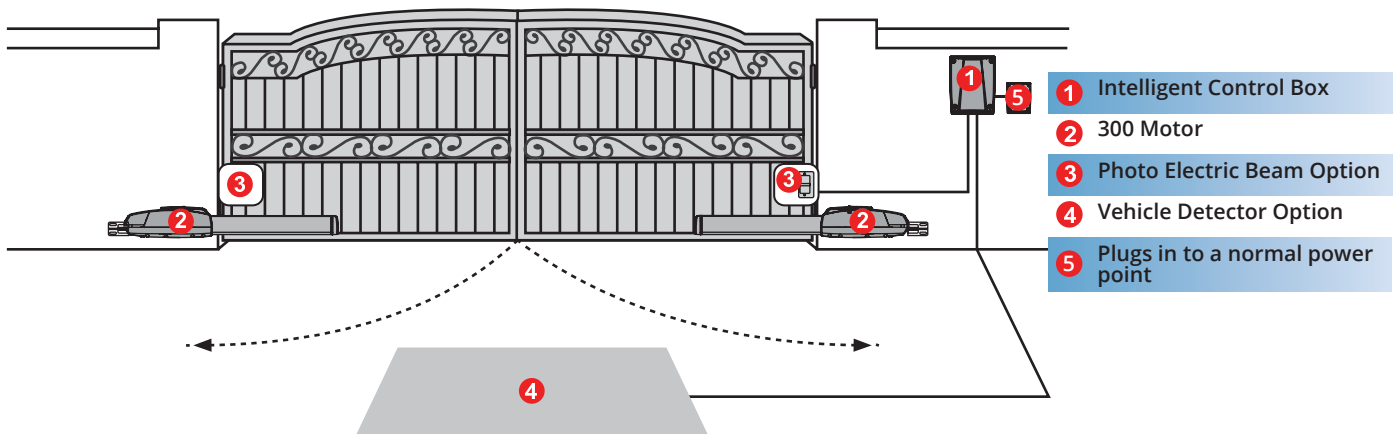

Single Kit Contents

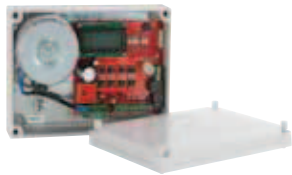

Intelligent Control Box with Built-in Receiver.



iS300 Swing Motor with Built-in Stopper.



Two Keyring Remotes with Frequency Hopping.



Dual Kit Contents

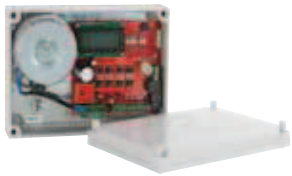

Intelligent Control Box with Built-in Receiver.



iS300 Dual Swing Motors with Built-in Stopper.



Two Keyring Remotes with Frequency Hopping.



Dimensions

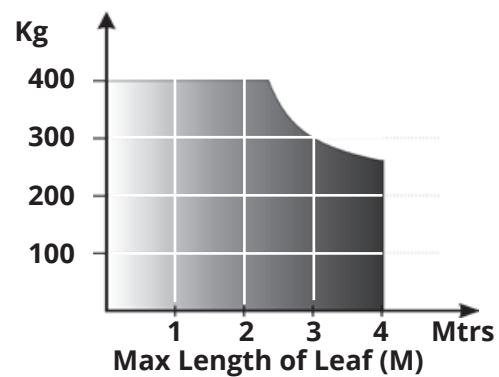
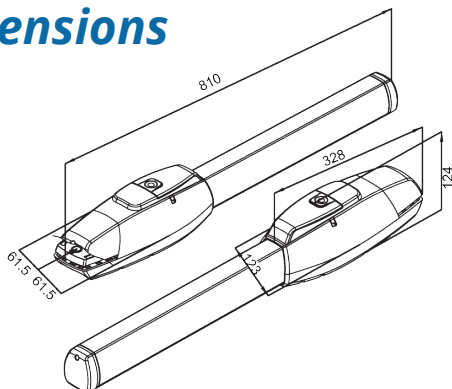

Optional Accessories



GSM Gate Opener.

Open your gate with your mobile phone for free!



Backup Battery.

24V, 7Ah Rechargeable lead acid Battery.



Magnetic Lock.

12V or 24V DC. Waterproof. 270Kg or 650Kg.



Vehicle Detector Beams.

Fadini Orbita.